

4

3

2

1

A

B

C

D

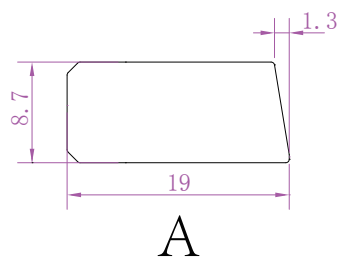
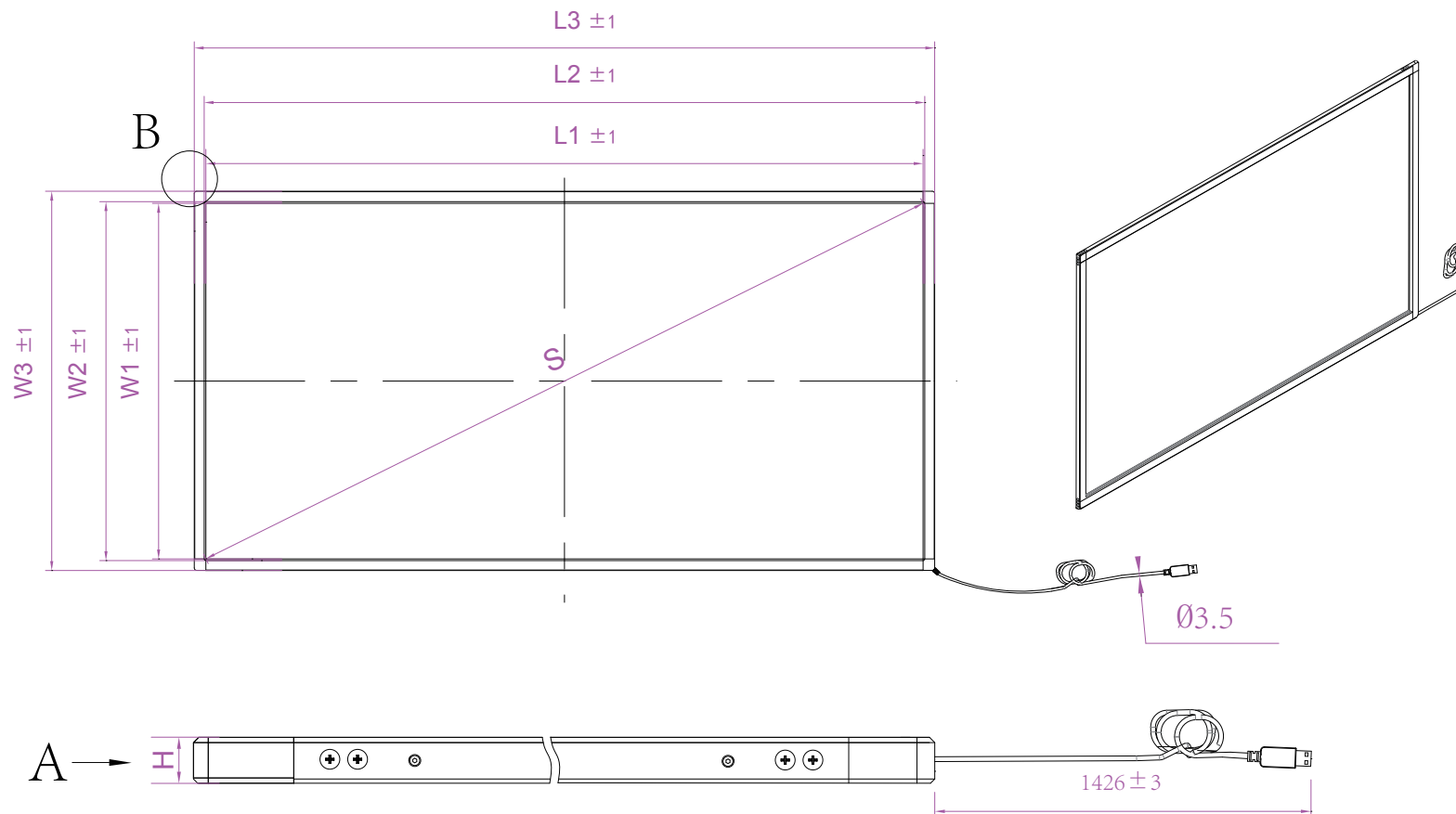
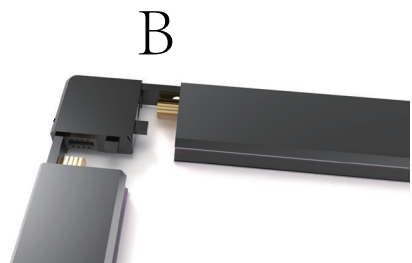

S(Inch/mm)	37.16"/944.00
W1	466.6 ± 1
W2	469.2 ± 1
W3	504.6 ± 1
L1	820.6 ± 1
L2	823.2 ± 1
L3	858.6 ± 1
H	8.7 ± 0.2



Anti-Sunlight, No Blind Zone For Any Size



X Slim Series							
Material:	aluminum	Unit:	mm	Date:		Rev:	1.0
Draft by:				Approved by:			

4

3

2

1